

Microcontroller

Breeze V1.0
www.dizzy.co.za
 Designed in Proteus
www.labcenter.co.uk

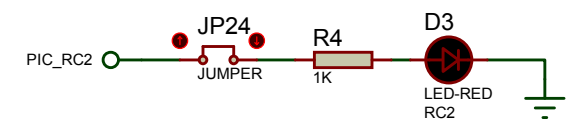

Connectors

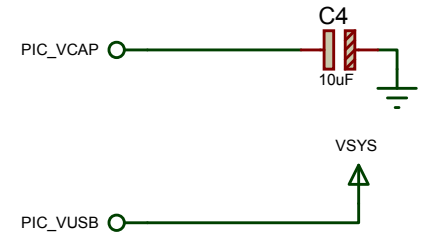
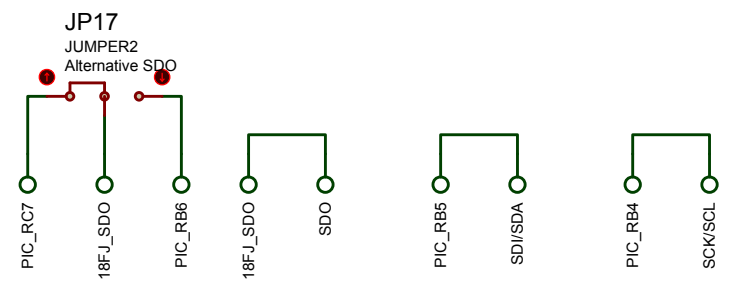
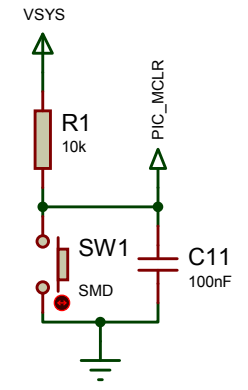
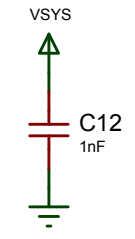
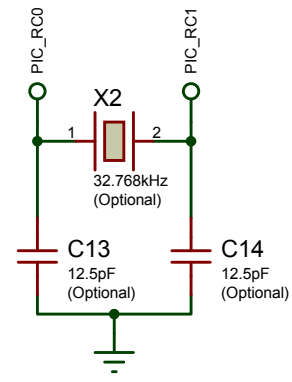
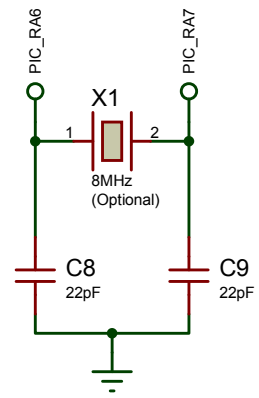
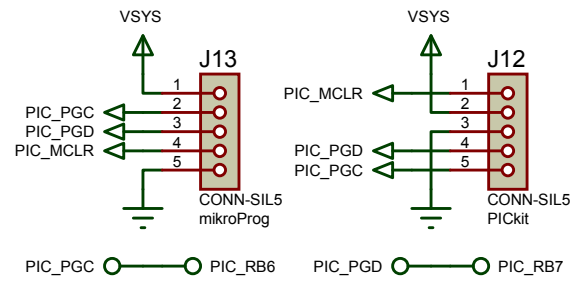
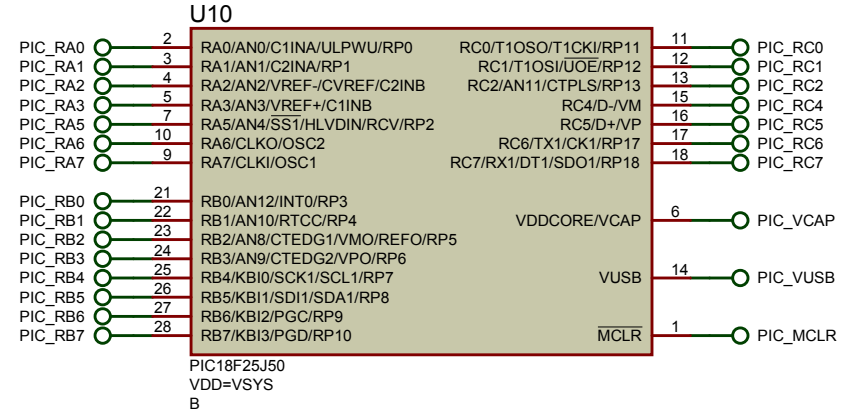
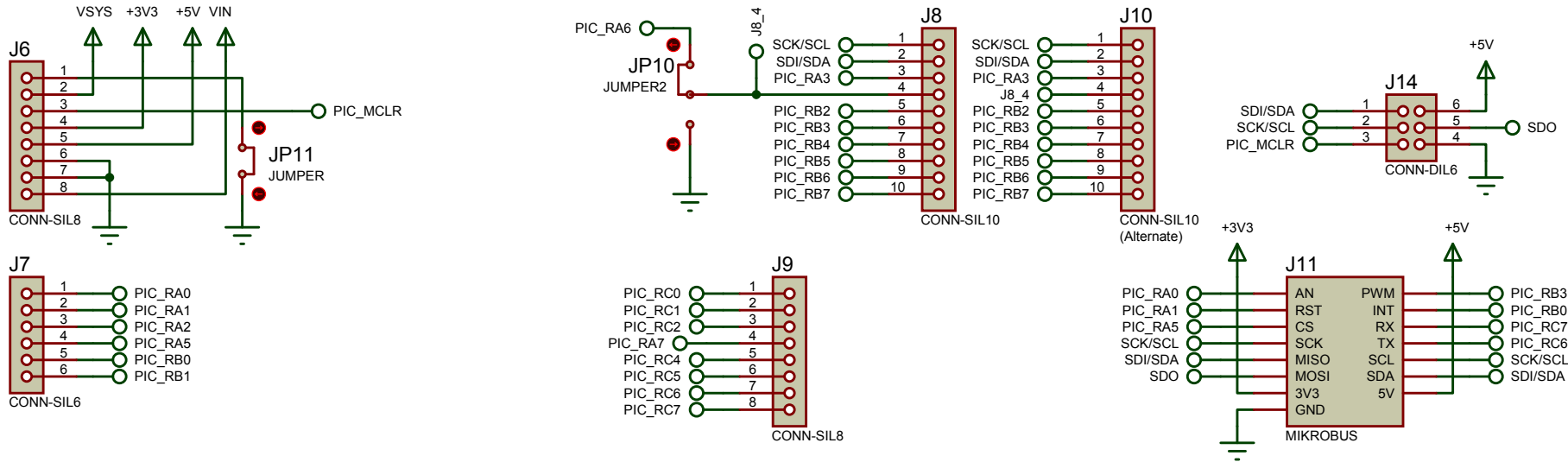

Power Supply

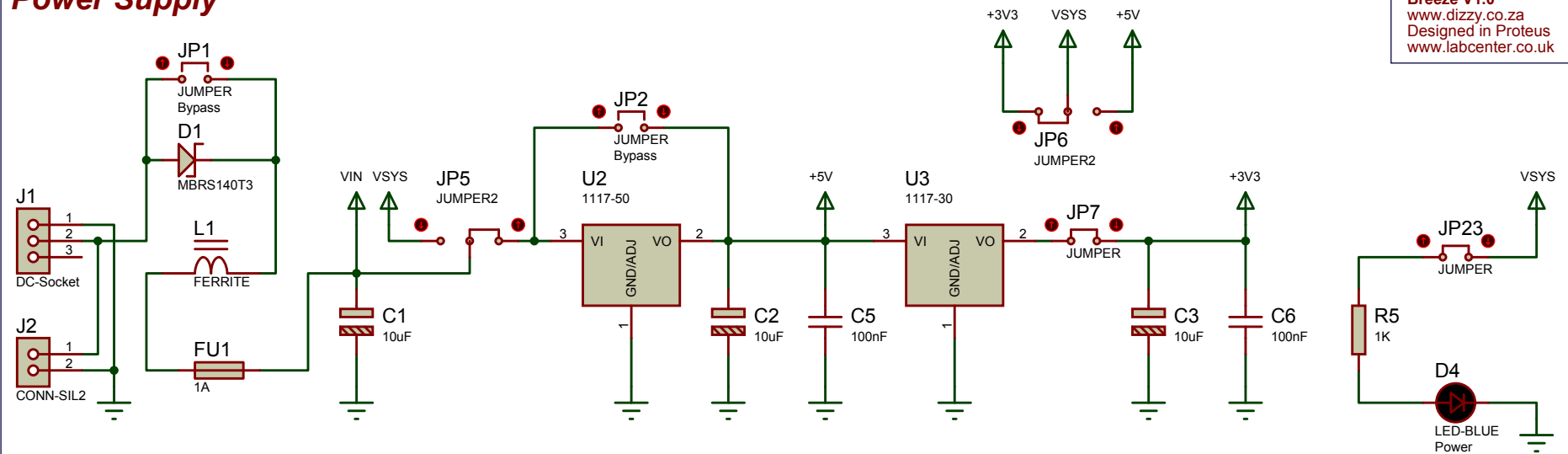

Breeze V1.0
www.dizzy.co.za
 Designed in Proteus
www.labcenter.co.uk

USB

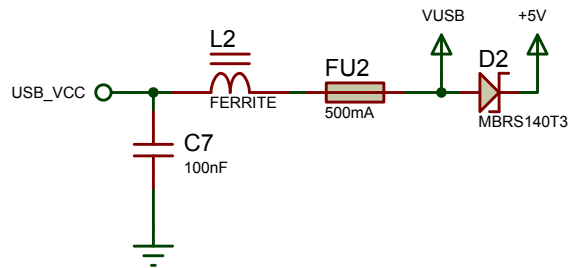
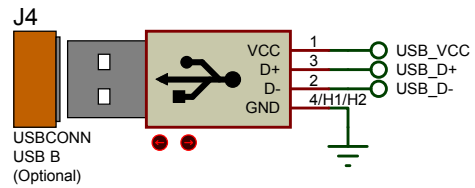
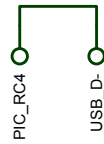
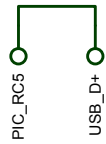
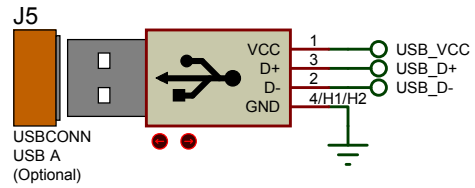
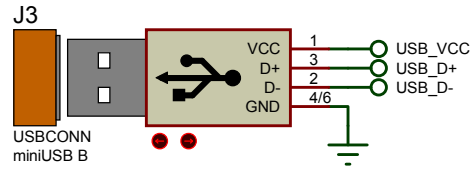

Breeze V1.0
www.dizzy.co.za
Designed in Proteus
www.labcenter.co.uk

microSD

