

Microcontroller

Breeze V1.1
 www.dizzy.co.za
 Designed in Proteus
 www.labcenter.co.uk

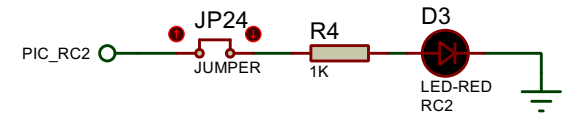

Connectors

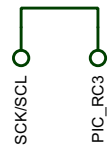
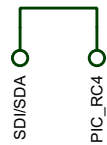
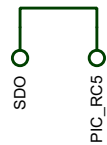
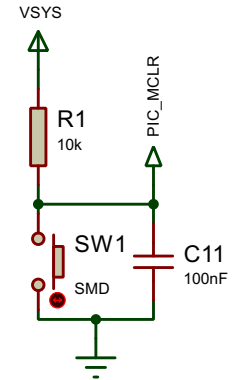
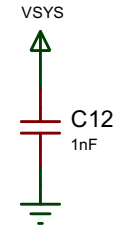
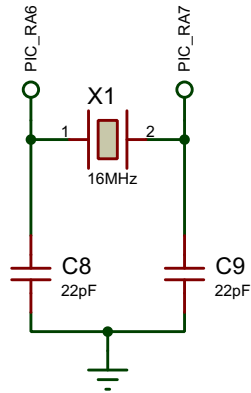
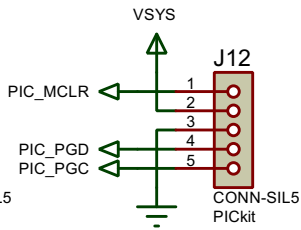
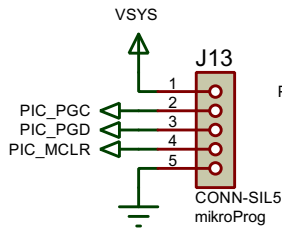
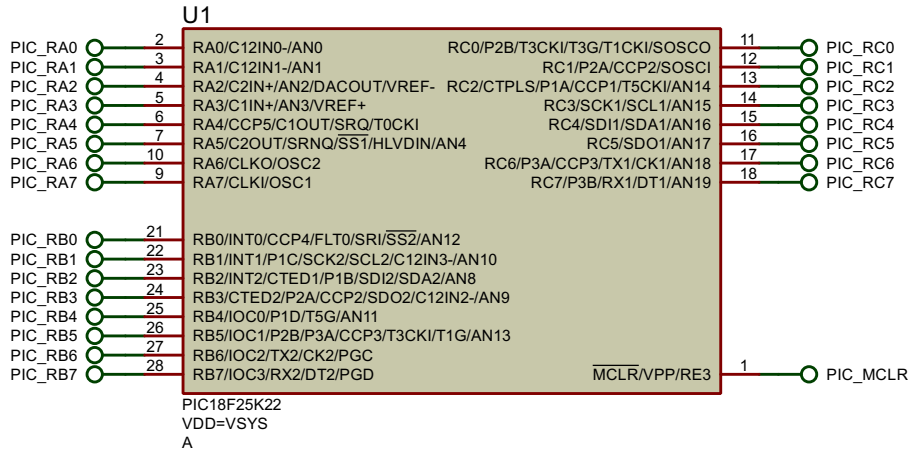
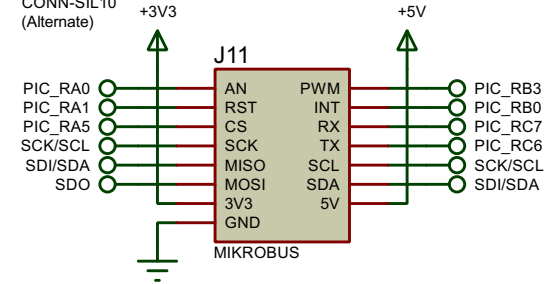
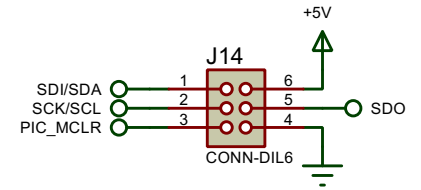
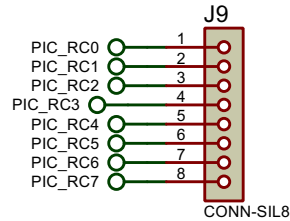
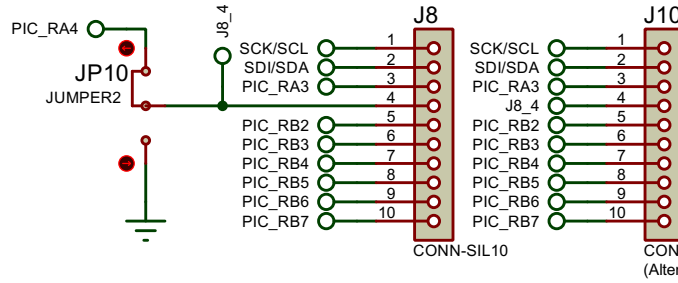
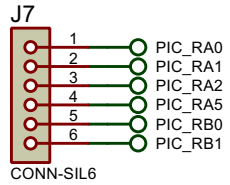
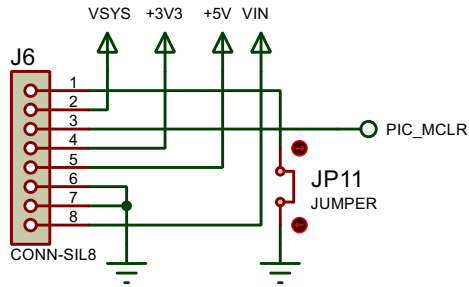

Power Supply

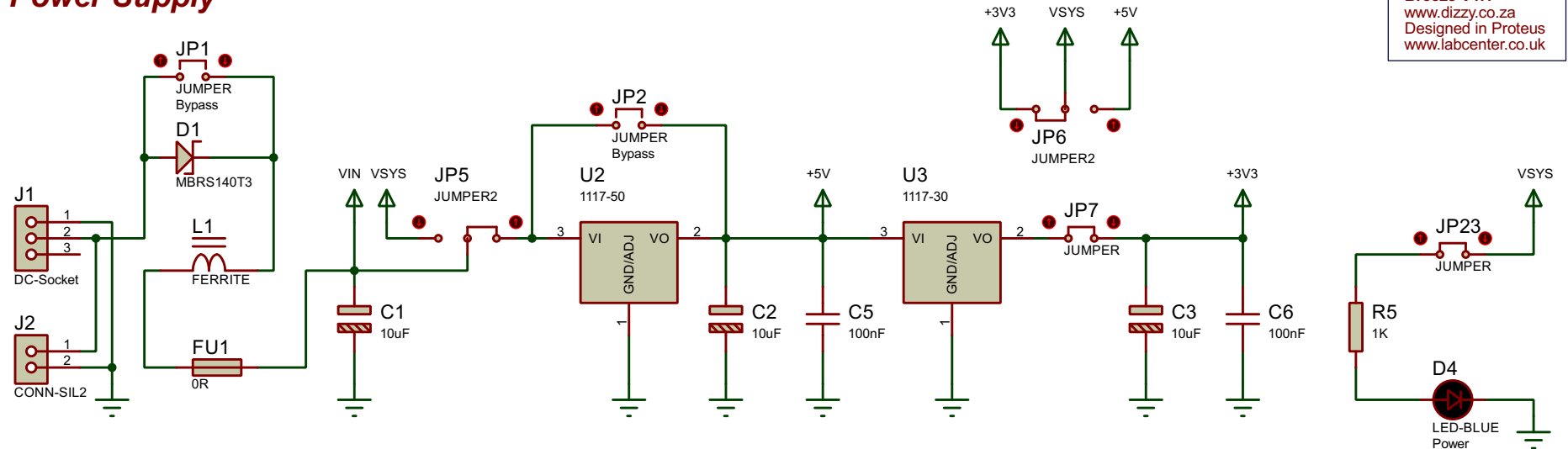

Breeze V1.1
www.dizzy.co.za
Designed in Proteus
www.labcenter.co.uk

USB

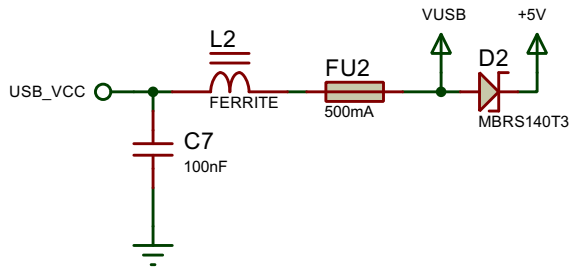
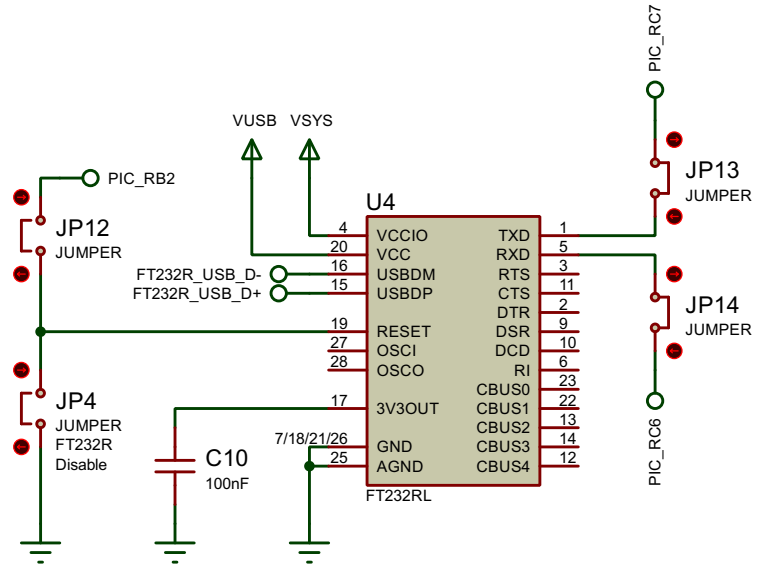
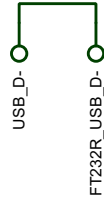
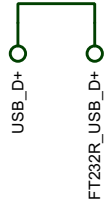
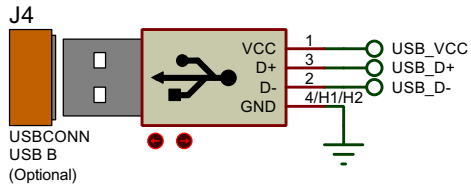
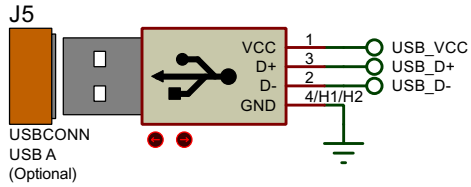
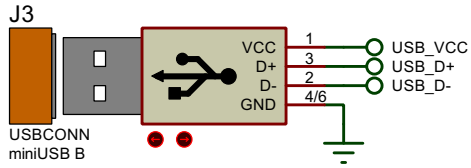

microSD

