

# Microcontroller

Breeze V1.1  
 www.dizzy.co.za  
 Designed in Proteus  
 www.labcenter.co.uk

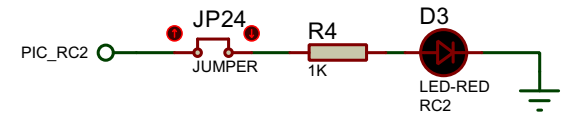

# Connectors

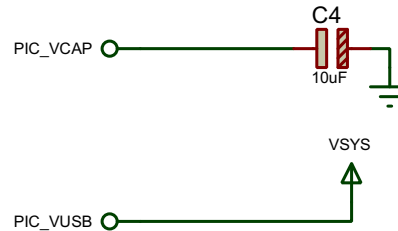
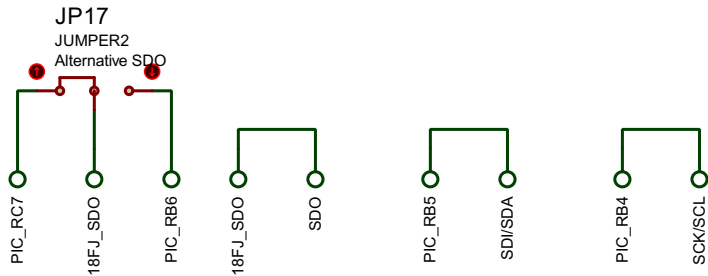
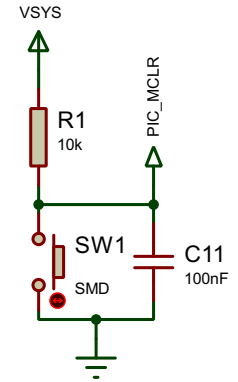
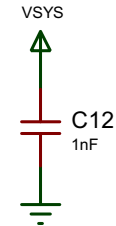
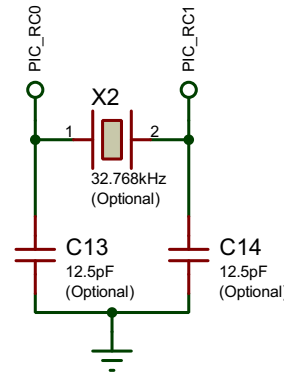
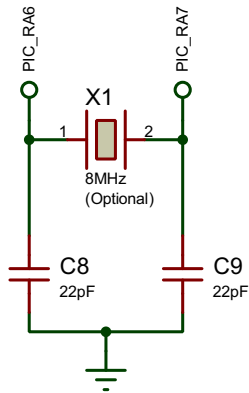
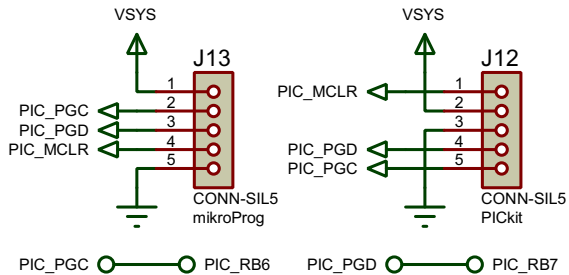
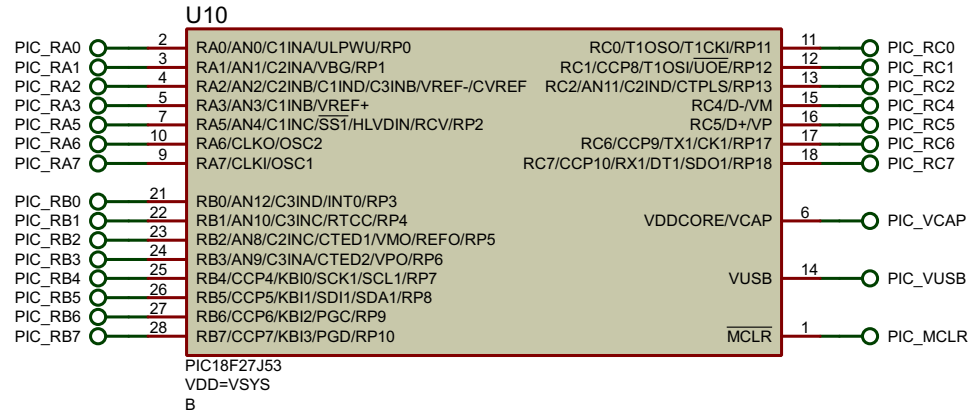
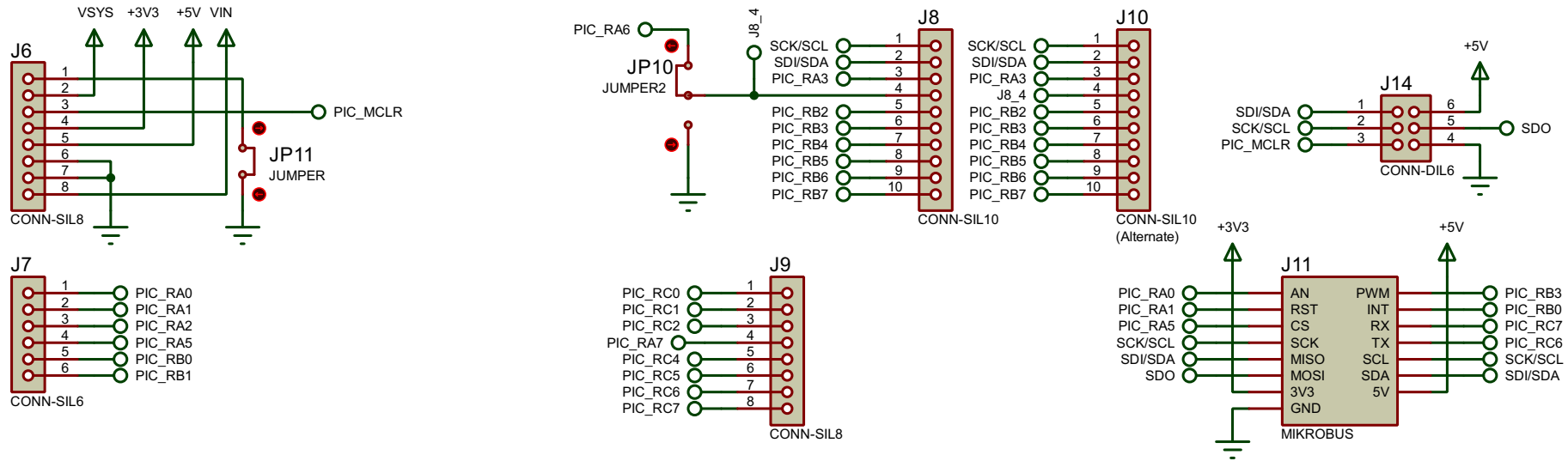

# Power Supply

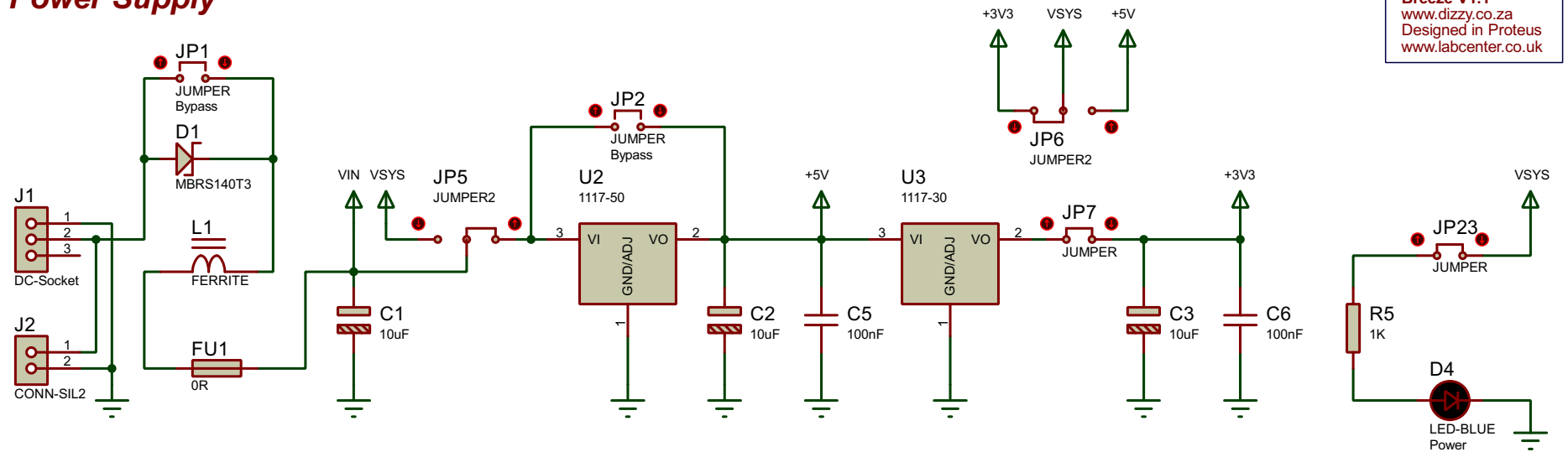

**Breeze V1.1**  
[www.dizzy.co.za](http://www.dizzy.co.za)  
 Designed in Proteus  
[www.labcenter.co.uk](http://www.labcenter.co.uk)

# USB

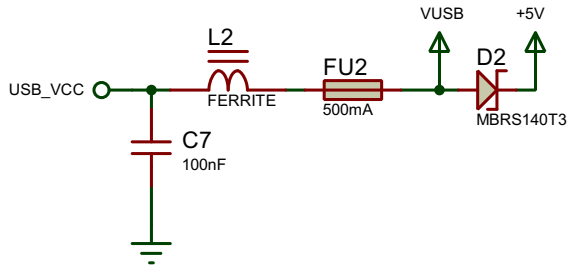
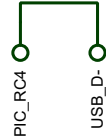
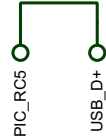
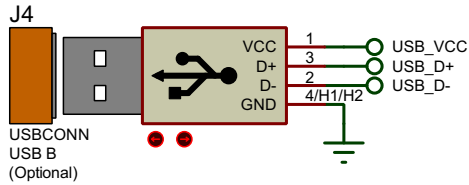
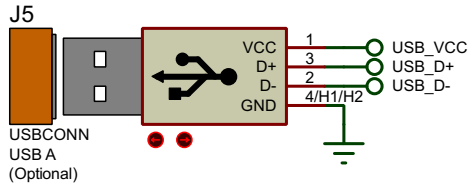
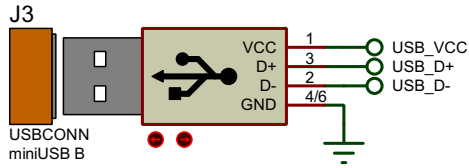

**Breeze V1.1**  
www.dizzy.co.za  
Designed in Proteus  
www.labcenter.co.uk

# microSD

